

TEMPERATURE SENSORS WITH A STEM AND STAINLESS STEEL CONNECTION HEAD

051.15en

DESCRIPTION AND APPLICATION

These resistance-type sensors are intended for contact measurements of temperatures of liquid and gaseous substances. These sensors are produced in two versions: the small connection head with the resistance-type output and the big connection head with the output 4 to 20 mA. The sensors are designed to be used in the food-processing industry mainly. The sensor - central holder combination is suitable for temperature measurement in air condition ducts. The sensor - thermowell combination is suitable for temperature measurement in tubing. The sensor variant with welded thread is ideal for direct measuring of mediums in ducts. The standard temperature range in which the active sensors are allowed to be utilised is -50 to 150 °C, for the passive sensors the range is -50 to 200 °C. The sensors can be utilised for any control systems that are compatible with sensing element output signals or output signals quoted in the table of sensing element types. The sensors are designed to be operated in a chemically non-aggressive environment.



ACCESSORIES

- metal central holder K120
- stainless steel thermowell JS 130
- lead-in connector CONEC 43-00092
- connection cable with the straight-type RKT connector or with the rectangular-type RKWT connector
- screw with collet or cutting rings – if different lengths of stem immersion of the temperature sensor are set

DECLARATION, CERTIFICATES, CALIBRATION

Manufacturer provides **EU Declaration of Conformity**.

Calibration – The final metrological inspection – comparison with standards or working instruments – is carried out for all the products. Continuity of the standards and working measuring instruments is ensured within the meaning of the Section 5 of Act no.505/1990 on metrology. The manufacturer offers a possibility to supply the sensors calibrated in SENSIT s.r.o.'s laboratory (according to requirements of the EN ISO/IEC 17025 standard, as amended) or in an Accredited laboratory.

SPECIFICATIONS

Sensor type (K – with connector)	NS 180P NS 180K	NS 181P NS 181K	NS 182P NS 182K	NS 380P NS 380K	NS 381P NS 381K
Type of sensing element	Ni 1000/5000	Ni 1000/6180	Ni 891	Ni 10000/5000	Ni 10000/6180
Measuring range	-50 to 200 °C (connection head ambient temperature -30 to 100 °C)				
Maximum measuring DC current	1 mA	1 mA	1 mA	0.3 mA	0.3 mA
Sensor type (K – with connector)	NS 183P NS 183K	PTS 180P PTS 180K	PTS 280P PTS 280K	PTS 380P PTS 380K	HS 180P HS 180K
Type of sensing element	T1 = Ni 2226	Pt 100/3850	Pt 500/3850	Pt 1000/3850	thermistor NTC 20 kΩ
Measuring range	-50 to 150 °C	-50 to 200 °C (connection head ambient temperature -30 to 100 °C)		-30 to 150 °C	
Maximum measuring DC current	0.7 mA	3 mA	1.5 mA	1 mA 1 mW *)	

*) maximum power consumption

Sensor type (K – with connector)	PTS 580P PTS 580K	Note
Type of sensing element	Pt 1000/3850	
Output signal	4 to 20 mA	
Measuring ranges	-50 to 50 °C -30 to 60 °C 0 to 35 °C 0 to 100 °C 0 to 150 °C	ambient temperature around the connection head -30 to 70 °C
Power supply (U)	11 to 30 V _{DC}	recommended value 24 V _{DC}
Load resistance	150 Ω for power supply 12 V 700 Ω for power supply 24 V	
Output signal - sensing element break	> 24 mA	
Output signal - sensing element short circuit	< 3.5 mA	

OTHER PARAMETERS ↓

Accuracy class	Ni sensing elements: B class, $t = \pm (0.4 + 0.007t)$, for $t \geq 0$; $t = \pm (0.4 + 0.028 t)$, for $t \leq 0$ in °C; Pt sensing elements: B class according to EN 60751, $t = \pm (0.3 + 0.005 t)$ in °C NTC 20 kΩ: ± 1 °C for the range 0 to 70 °C
Measuring error	< 0.6 % of the measuring range, minimum 0.5 °C
Sensor connection	according to the wiring diagram
Standard length of the stem L1	70, 120, 180, 240 mm
Time response	$\tau_{0,5} < 9$ s (in flowing water at 0.4 m.s ⁻¹)
Lead-in cable – version with cable	PVC shielded 2 x 0.25 mm ²
Type of connector in the head – sensors with connector	Lumberg RSFM4, M 12
Standard lengths of the cable	1, 2, 5, 10 m
Insulation resistance	> 200 MΩ at 500 V _{DC} , 25° ± 3 °C; humidity < 85 %
Ingress protection	IP 67 in accordance with EN 60529, as amended
Material of the stem	stainless steel DIN 1.4301
Material of the connection head	stainless steel DIN 1.4301
Operating conditions	ambient temperature: -30 to 100 °C; -30 to 70 °C with a converter relative humidity: max. 100 % (at the ambient temperature 25 °C) atmospheric pressure: 70 to 107 kPa
Weight approximately	0.25 kg

WIRING DIAGRAM

SENSORS WITH A CONNECTOR:

With resistance output

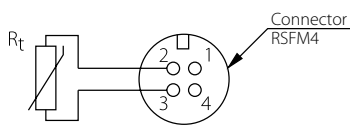

With current output

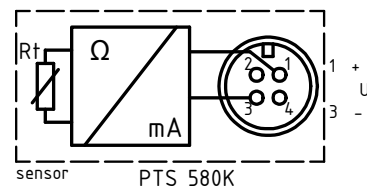

SENSORS WITH A GROMMET:

With cable

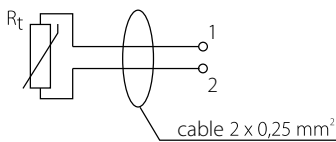

With cable

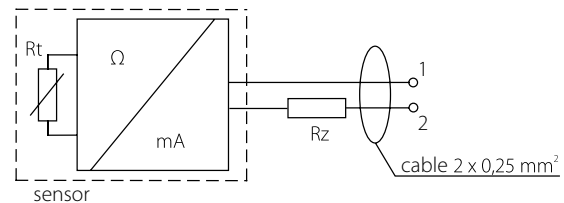

DIMENSIONAL DRAFT

SENSORS WITH CURRENT OUTPUT:

PTS 580P

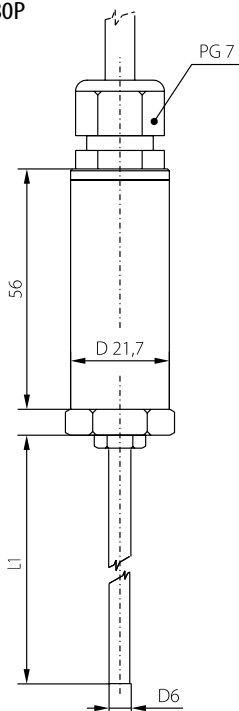

PTS 580K

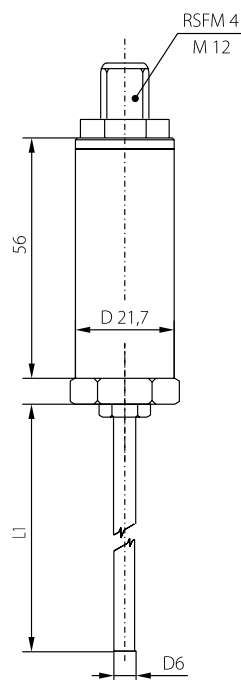

SENSORS WITH RESISTANCE OUTPUT:

xxSx8xP

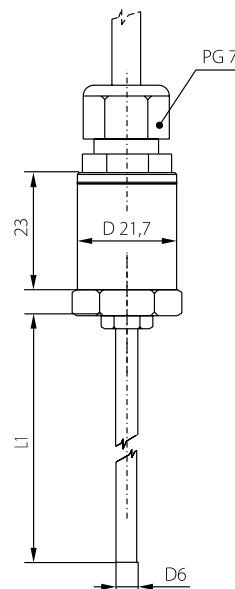

xxSx8xK

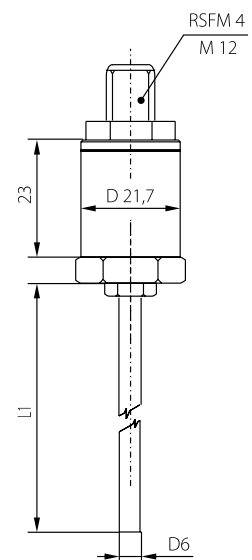

DIMENSIONAL DRAFT

Accessories

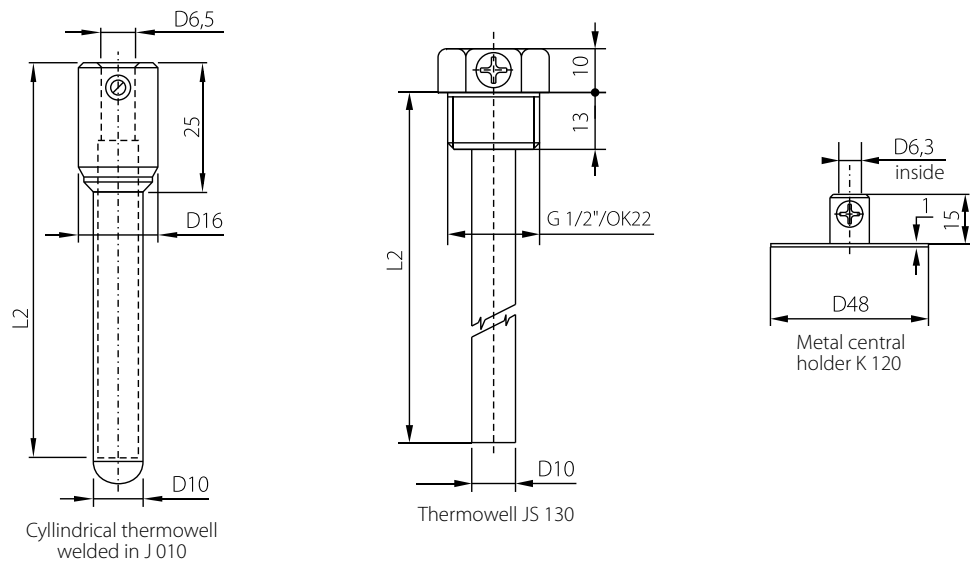

MODIFICATION AND CUSTOMIZATION

- option of encasing two sensing elements
- option of encasing non-standard temperature sensors (DALLAS, TSic, KTY, SMT, etc.)
- A class precision (with the exception of sensors Ni 10000/5000, Ni 10000/6180, T1 = Ni 2226, termistor NTC 20 k Ω)
- option of three- or four-wire connection
- variable stem design – L1 length, materials, diameters, option of thread design
- changing the sensor cable length – version with grommet
- thermowell thread type options

